

1N4148WS

Silicon Epitaxial Planar Switching Diode

Features

- SOD-323 package
- Fast switching
- These diodes are also available in other case style including the DO-35 case with the type designation 1N4148, the MiniMELF case with the type designation LL4148 and the MicroMELF case with the type designation MCL4148.

PINNING

PIN	DESCRIPTION
1	Cathode
2	Anode

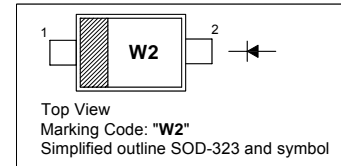

Absolute Maximum Ratings ($T_a = 25^\circ\text{C}$)

Parameter	Symbol	Value	Unit
Peak Reverse Voltage	V_{RM}	100	V
Reverse Voltage	V_R	75	V
Average Rectified Forward Current	$I_{F(AV)}$	150	mA
Surge Forward Current ($t < 1\text{ s}$, $T_j = 25^\circ\text{C}$)	I_{FSM}	350	mA
Power Dissipation	P_{tot}	200	mW
Thermal Resistance from Junction to Ambient Air	$R_{\theta JA}$	625	$^\circ\text{C/W}$
Junction Temperature	T_j	150	$^\circ\text{C}$
Storage Temperature Range	T_{stg}	- 65 to + 150	$^\circ\text{C}$

Electrical Characteristics ($T_a = 25^\circ\text{C}$)

Parameter	Symbol	Max.	Unit
Forward Voltage at $I_F = 10\text{ mA}$	V_F	1	v
Reverse Current at $V_R = 20\text{ V}$ at $V_R = 75\text{ V}$ at $V_R = 20\text{ V}$, $T_j = 150^\circ\text{C}$	I_R	25 5 50	nA μA μA
Total Capacitance at $V_R = 0\text{ V}$, $f = 1\text{ MHz}$	C_{tot}	4	pF
Reverse Recovery Time at $I_F = 10\text{ mA}$ to $I_R = 1\text{ mA}$, $V_R = 6\text{ V}$, $R_L = 100\ \Omega$	t_{rr}	4	ns

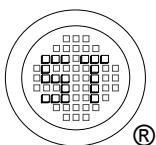

SEMTECH ELECTRONICS LTD.

(Subsidiary of Sino-Tech International Holdings Limited, a company listed on the Hong Kong Stock Exchange, Stock Code: 724)

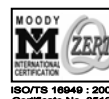

1N4148WS

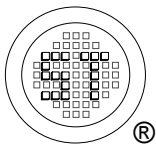
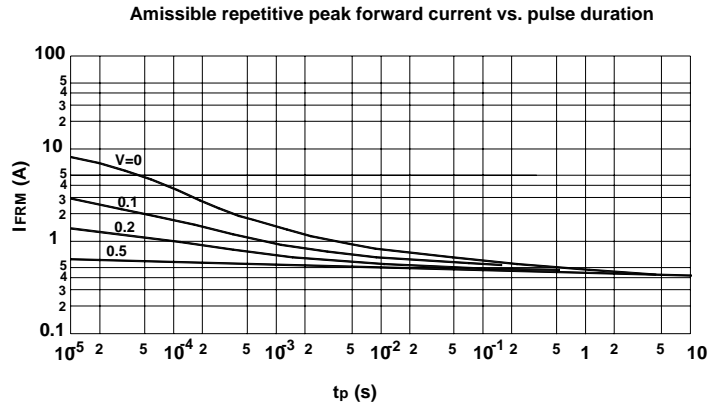
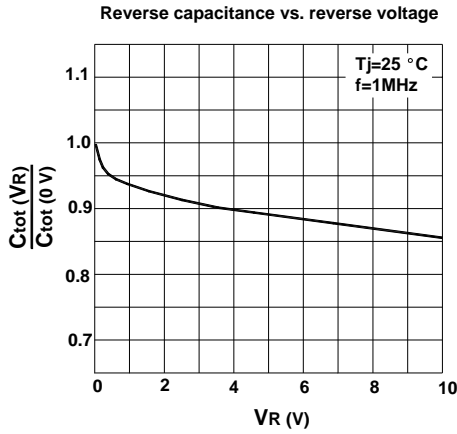
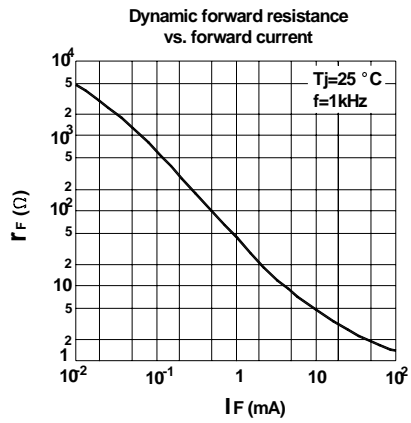
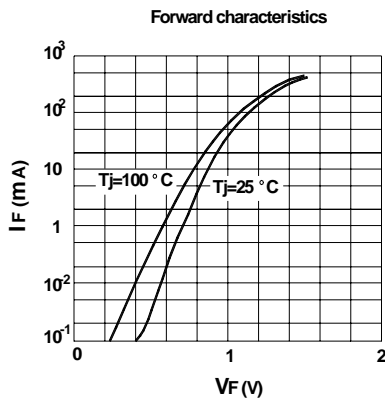

SEMTECH ELECTRONICS LTD.
 (Subsidiary of Sino-Tech International Holdings Limited, a company listed on the Hong Kong Stock Exchange, Stock Code: 724)

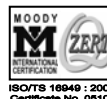

ISO/TS 16949:2002 Certificate No. 05103 | ISO 14001:2004 Certificate No. 7116 | ISO 9001:2000 Certificate No. 050059 | BS-OHSAS 18001:2007 Certificate No. 7116 | IECQ QC 080000 Certificate No. 19C080001

1N4148WS

PACKAGE OUTLINE

Plastic surface mounted package; 2 leads

SOD-323

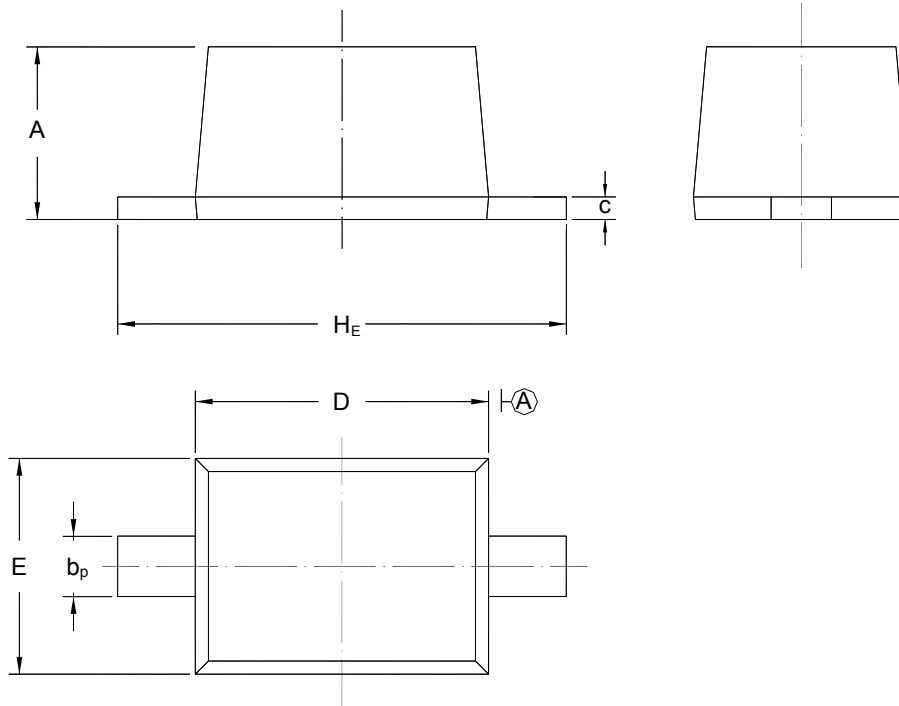

UNIT	A	b _p	C	D	E	H _E
mm	1.10 0.80	0.40 0.25	0.15 0.00	1.80 1.60	1.35 1.15	2.80 2.30

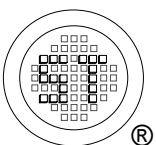

SEMTECH ELECTRONICS LTD.
 (Subsidiary of Sino-Tech International Holdings Limited, a company listed on the Hong Kong Stock Exchange, Stock Code: 724)

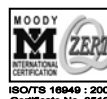

ISO/TS 16949 : 2002
Certificate No. 05103

ISO 14001:2004
Certificate No. 7116

ISO 9001:2000
Certificate No. 0500598

BS-OHSAS 18001: 2007
Certificate No. 7116

IECQ QC 080000
Certificate No. 05103

Dated : 15/06/2009

1N4148WS

PACKAGE OUTLINE

Plastic surface mounted package; 2 leads

SOD-323

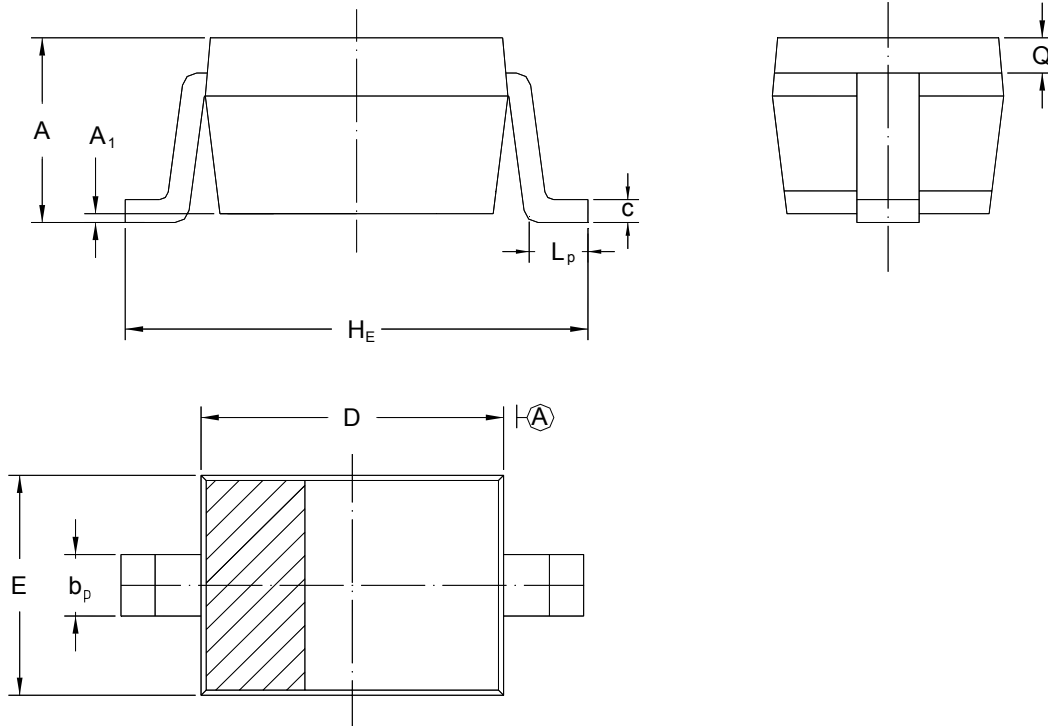

UNIT	A	A ₁	b _p	C	D	E	H _E	L _p	Q
mm	1.10 0.80	0.1 0	0.40 0.25	0.15 0.00	1.80 1.60	1.35 1.15	2.80 2.30	0.50 0.10	0.15 REF.

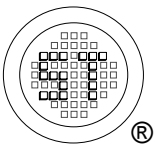

SEMTECH ELECTRONICS LTD.
 (Subsidiary of Sino-Tech International Holdings Limited, a company listed on the Hong Kong Stock Exchange, Stock Code: 724)

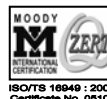

ISO/TS 16949:2002 Certificate No. 08103
 ISO 14001:2004 Certificate No. 7116
 ISO 9001:2000 Certificate No. 080058
 BS-OHSAS 18001:2007 Certificate No. 7116
 IECQ QC 080000 Certificate No. PC88P881

Dated : 15/06/2009