

SDS511

Silicon Epitaxial Planar Switching Diode

Features

- Ultra high speed switching application
- Low forward voltage
- Fast reverse recovery time
- Small total capacitance

PINNING

PIN	DESCRIPTION
1	Cathode
2	Anode

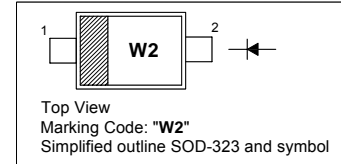

Absolute Maximum Ratings ($T_a = 25\text{ }^\circ\text{C}$)

Parameter	Symbol	Value	Unit
Peak Reverse Voltage	V_{RM}	85	V
Reverse Voltage	V_R	80	V
Average Rectified Forward Current	$I_{F(AV)}$	100	mA
Peak Forward Current	I_{FM}	300	mA
Surge Current (10 ms)	I_{FSM}	2	A
Power Dissipation	P_{tot}	150	mW
Junction Temperature	T_j	150	$^\circ\text{C}$
Storage Temperature Range	T_{stg}	- 55 to + 150	$^\circ\text{C}$

Characteristics at $T_a = 25\text{ }^\circ\text{C}$

Parameter	Symbol	Max.	Unit
Forward Voltage at $I_F = 100\text{ mA}$	V_F	1.2	V
Reverse Current at $V_R = 80\text{ V}$	I_R	0.5	μA
Total Capacitance at $V_R = 0\text{ V}$, $f = 1\text{ MHz}$	C_{tot}	4	pF
Reverse Recovery Time at $I_F = I_R = 10\text{ mA}$ to $I_R = 1\text{ mA}$, $R_L = 100\ \Omega$	t_{rr}	4	ns

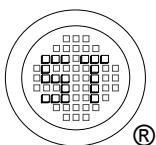

SEMTECH ELECTRONICS LTD.

(Subsidiary of Sino-Tech International Holdings Limited, a company listed on the Hong Kong Stock Exchange, Stock Code: 724)

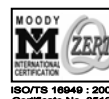

Fig. 1 I_F-V_F

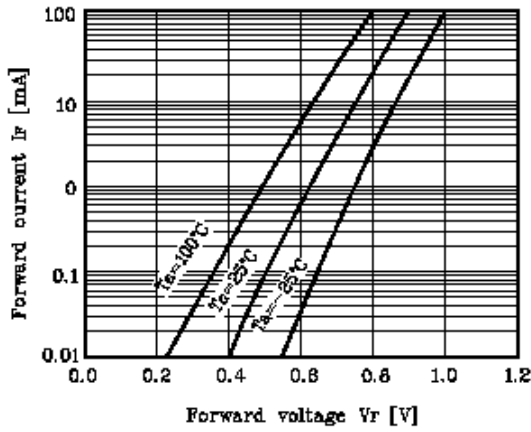

Fig. 2 I_R-V_R

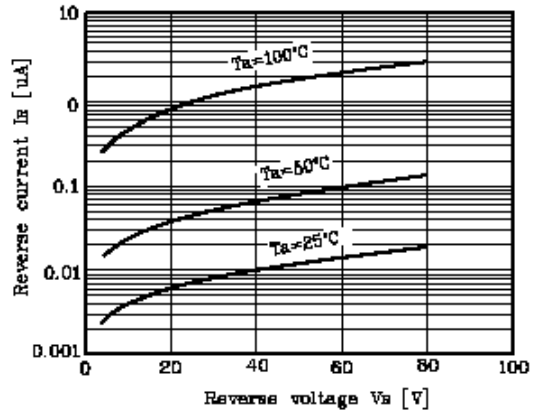

Fig. 3 C_T-V_R

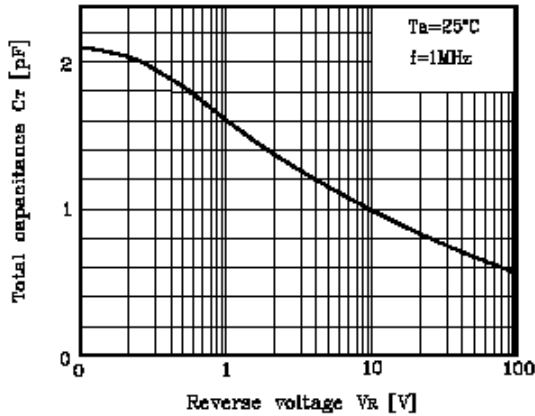
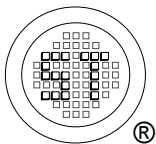
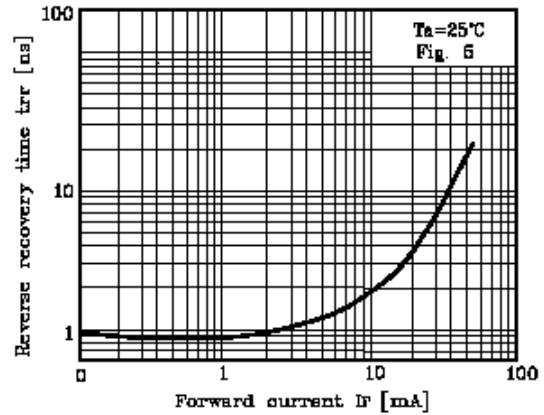
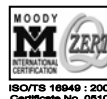

Fig. 4 $t_{rr}-I_F$



SEMTECH ELECTRONICS LTD.
 (Subsidiary of Sino-Tech International Holdings Limited, a company listed on the Hong Kong Stock Exchange, Stock Code: 724)



ISO/TS 16949:2002 Certificate No. 05103 | ISO 14001:2004 Certificate No. 7116 | ISO 9001:2000 Certificate No. 050059 | BS-OHSAS 18001:2007 Certificate No. 7116 | IECQ QC 080000 Certificate No. 7116

PACKAGE OUTLINE

Plastic surface mounted package; 2 leads

SOD-323

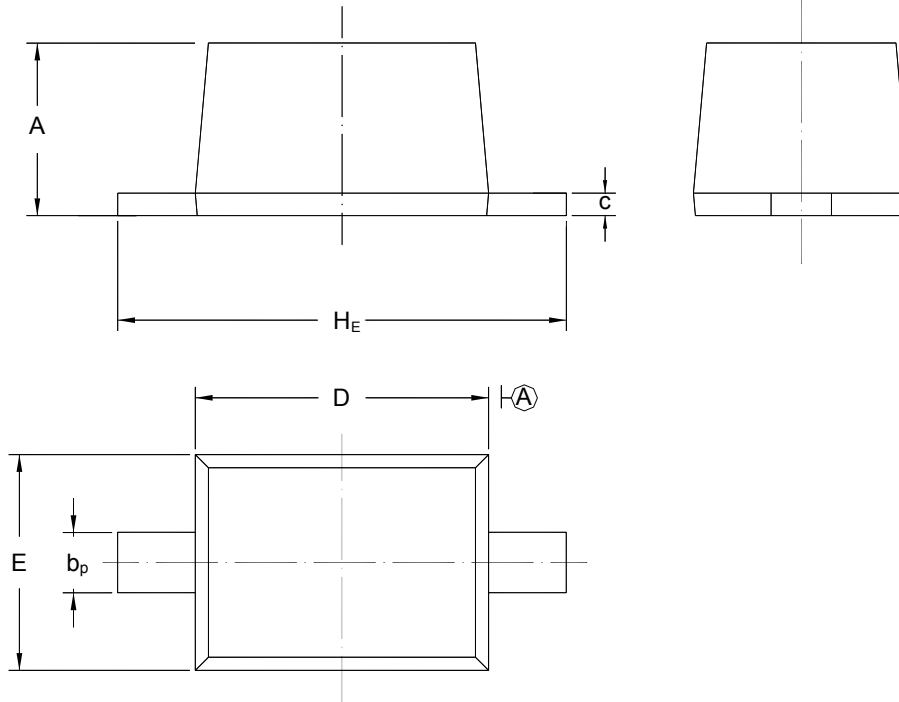

UNIT	A	b _p	C	D	E	H _E
mm	1.10 0.80	0.40 0.25	0.15 0.00	1.80 1.60	1.35 1.15	2.80 2.30

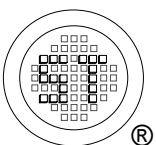

SEMTECH ELECTRONICS LTD.
 (Subsidiary of Sino-Tech International Holdings Limited, a company listed on the Hong Kong Stock Exchange, Stock Code: 724)

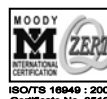

ISO/TS 16949:2002
Certificate No. 05103

ISO 14001:2004
Certificate No. 7116

ISO 9001:2000
Certificate No. 050059

BS-OHSAS 18001:2007
Certificate No. 7116

IECQ QC 080000
Certificate No. 7116